

Product Specification

Original Date	31/07/2013
PN:	ZTTCP



Abundance Enterprise Co.

PRODUCT SPECIFICATION

CERAMIC RESONATOR

AEC PART NUMBER / SPEC. NO: ZTTCP3.58MG

CUSTOMER: Schukat electronic Vertriebs GmbH



Peak soldering temperature 260°C /10 sec

Ceramic component is exempted (According to ROHS directive

2005/95/EC ANNEX point 7)

Customer's Name	Schukat electronic Vertriebs GmbH
Production Name	Ceramic Resonator
Frequency	3.58MHz
Model No	ZTTCP3.58MG
Issue Date	15 th Oct, 2013

Address: Room 602-603, Java Commercial Centre,

128 Java Road,

North Point, Hong Kong

Homepage: <http://www.aeccrystal.com/>

Email: sales@aeccrystal.com

Telephone: (852)-28560000 Fax (852) 2561 2161

Prepared	Inspection	Approved
Nathan	Andy	Henkie

1. SCOPE

This specification shall cover the characteristics of the ceramic resonator with the type ZTTCP3.58MG

2. PART NO.:

PART NUMBER	CUSTOMER PART NO	SPECIFICATION NO
ZTTCP3.58MG		

3. OUTLINE DRAWING AND DIMENSIONS:

3.1 Appearance: No visible damage and dirt.

3.2 Dimensions:

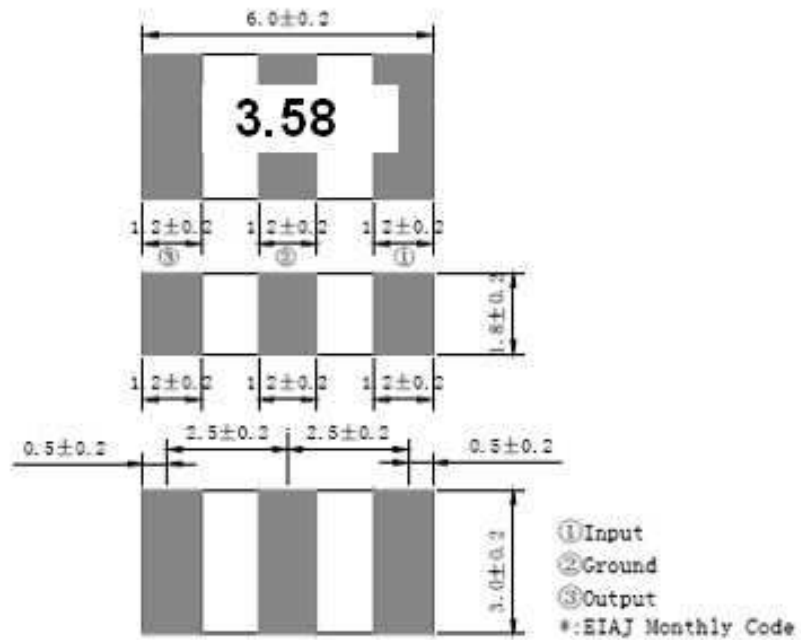

Unit: mm

4. ELECTRICAL SPECIFICATIONS:

	Item	Requirements
4.1	Oscillation Frequency F_{osc} (MHz)	3.58
	Frequency Accuracy (%)	± 0.5
4.2	Resonant Impedance R_o (Ω) max	40
4.3	Temperature Coefficient of Oscillation Frequency (%) max	± 0.3 (Oscillation Frequency drift -20°C to $+85^\circ\text{C}$)
4.4	Withstanding Voltage	100 VDC, 5 sec
4.5	Rating Voltage U_R (V) (1) D.C. Voltage (2) A.C. Voltage	6 VDC. 15 Vp-p.
4.6	Insulation Resistance R_i ($M\Omega$) min	500 (10V, 1min)
4.7	Operating Temperature ($^\circ\text{C}$)	$-20 \sim +85$
4.8	Storage Temperature ($^\circ\text{C}$)	$-55 \sim +85$
4.9	Aging Rate (%) max	± 0.1 From initial value

Components shall be left in a chamber of $+85 \pm 2^\circ\text{C}$ for 1000 hours, then measured after leaving in natural condition for 1 hours.

4. MEASUREMENT:

4.1 Measurement Conditions: Parts shall be measured under a condition (Temp.: $20 \pm 15^\circ\text{C}$, Humidity : $65 \pm 20\%$ R.H.) unless the standard condition (Temp.: $25 \pm 3^\circ\text{C}$, Humidity : $65 \pm 5\%$ R.H.) is regulated to measure.

4.2 Test Circuit:

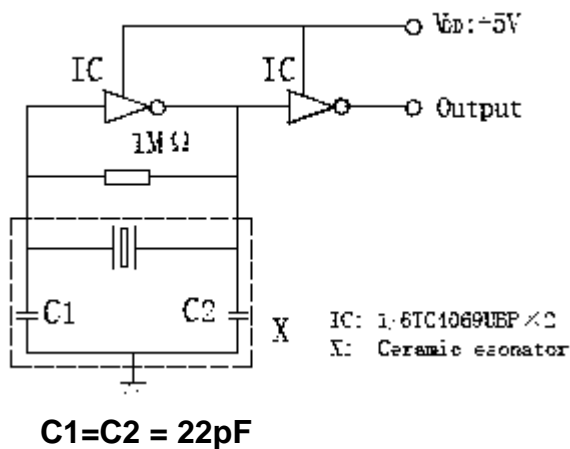

5. PHYSICAL AND ENVIRONMENTAL CHARACTERISTICS

No	Item	Condition of Test	Performance Requirements	
6.1	Humidity	Keep the resonator at $40\pm 2^{\circ}\text{C}$ and 90-95% RH for 96 ± 4 hours. Then Release the resonator into the room Condition for 1 hour prior to the Measurement.	It shall fulfill the specifications in Table 1.	
6.2	Vibration	Subject the resonator to vibration for 2 hours each in x 、 y and z axis With the amplitude of 1.5mm, the frequency shall be varied uniformly between the limits of 10 Hz—55Hz.	It shall fulfill the specifications in Table 1.	
6.3	Mechanical Shock	Drop the resonator randomly onto a wooden floor from the height of 100cm 3 times.	It shall fulfill the specifications in Table 1.	
6.4	Soldering Test	Passed through the re-flow oven under the following condition and left at room temperature for 1 hour before measurement.	It shall fulfill the specifications in Table 1.	
		Temperature at the surface of the substrate		Time
		Preheat $150\pm 5^{\circ}\text{C}$		60 ± 10 sec
		Peak $260\pm 5^{\circ}\text{C}$		10 ± 3 sec
6.5	Solder Ability	Dipped in $250\pm 5^{\circ}\text{C}$ solder bath for 3 ± 0.5 sec seconds with rosin flux (25wt% ethanol solution.)	The terminals shall be at least 95% covered by solder.	
6.6	High Temperature Exposure	Subject the resonator to $80\pm 5^{\circ}\text{C}$ for 96 hours, then release the resonator into the room conditions for 1 hour prior to the measurement.	It shall fulfill the specifications in Table 1.	
6.7	Low Temperature Exposure	Subject the resonator to $-20\pm 5^{\circ}\text{C}$ for 96 hours, then release the resonator into the room conditions for 1 hour prior to the measurement.	It shall fulfill the specifications in Table 1.	

No	Item	Condition of Test	Performance Requirements
6.8	Temperature Cycling	Subject the resonator to -40°C for 30 min. followed by a high temperature of 85°C for 30 min. Cycling shall be repeated 5 times with a transfer time of 15 sec. At the room temperature for 1 hour prior to the measurement.	It shall fulfill the specifications in Table 1.
6.9	Board Bending	Mount a glass-epoxy board (Width=40mm,thickness=1.6mm),then bend it to 1mm displacement and keep it for 5 seconds. (See the following figure)	Mechanical damage such as breaks shall not occur.

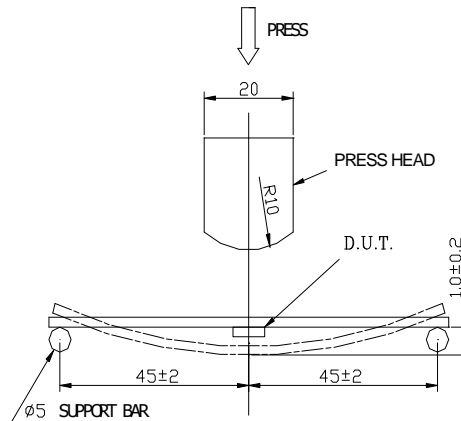

TABLE 1

Item	Specification
Oscillation Frequency Change $\Delta F_{osc}/F_{osc}$ (%) max	± 0.3
Resonant Impedance $R_o(\Omega)$ max	45

Note: The limits in the above table are referenced to the initial measurements.

6. REVIEW OF SPECIFICATIONS

When something gets doubtful with this specifications, we shall jointly work to get an agreement.

7. RECOMMENDED LAND PATTERN AND REFLOW SOLDERING

STANDARD CONDITIONS

8.1 Recommended land pattern

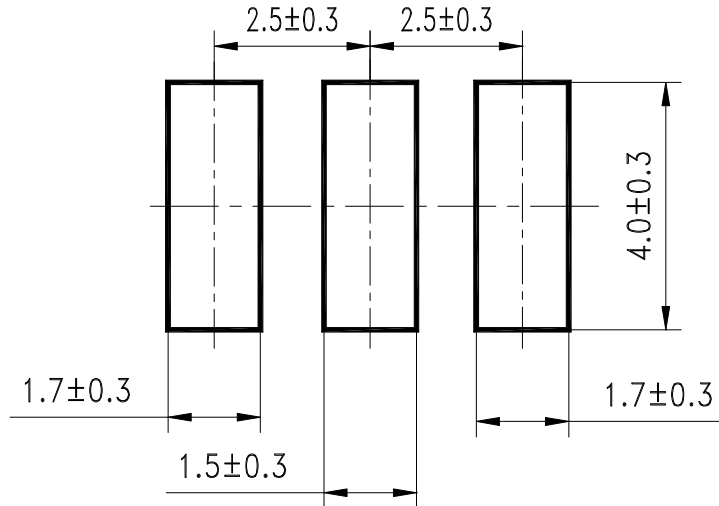

8.2 Recommended reflow soldering standard conditions

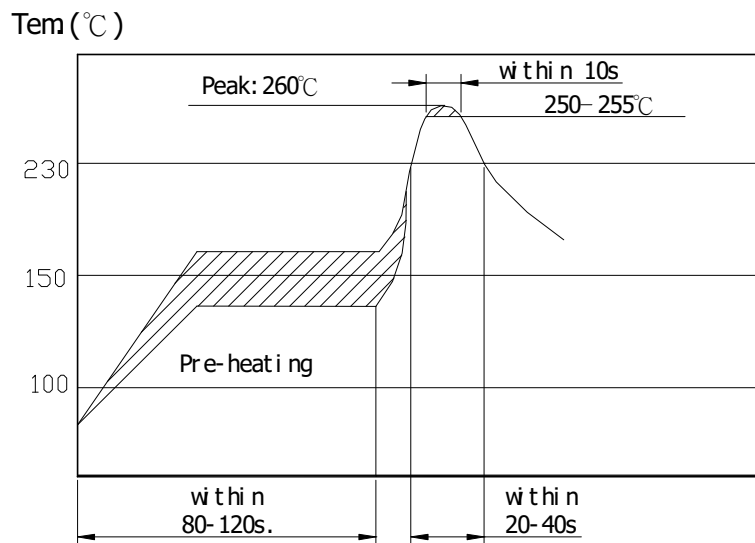

8. PACKAGE

To protect the products in storage and transportation, it is necessary to pack them (outer and inner package). On paper pack, the following requirements are requested.

8.1 Dimensions and Mark

At the end of package, the warning (moisture proof, upward put) should be stick to it.

Dimensions and Mark (see below)

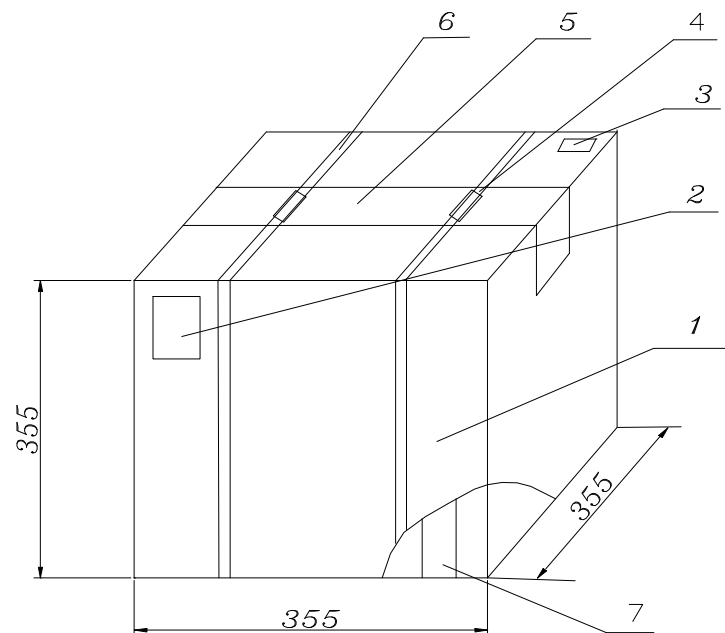

NO.	Name	Quantity	Notes
1	Package	1	
2	Certificate of approval	1	
3	Label	1	
4	Tying	2	
5	Adhesive tape	1.2m	
6	Belt	2.9m	
7	Inner Box	10	

8.2 Section of package

Package is made of corrugated paper with thickness of 0.8cm. Package has 10 inner boxes, each box has 1 reel (each reel for plastic bag).

8.3 Quantity of package

Per plastic reel 4000 pieces of piezoelectric ceramic part
Per inner box 1 reel
Per package 10 inner boxes(40000 pieces of piezoelectric ceramic part)

8.4 Inner Packing Dimensions

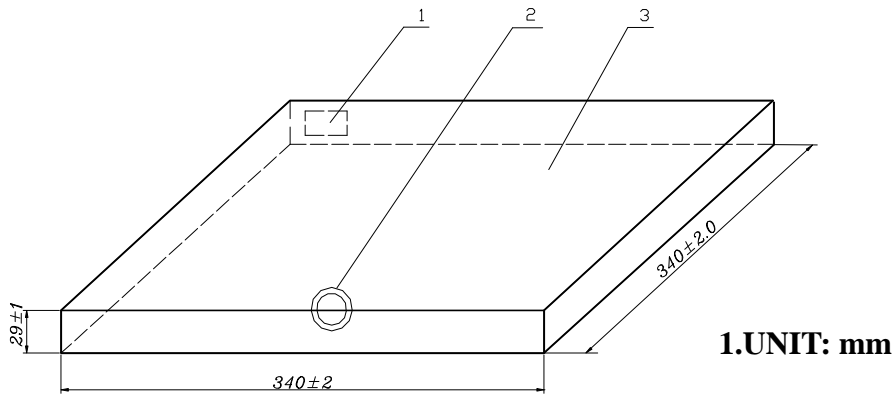

1	Label
2	QC Label
3	Inner Box

Pars shall be packaged in box with hold down tape upside. Part No., quantity and lot No.

8.5 Reel

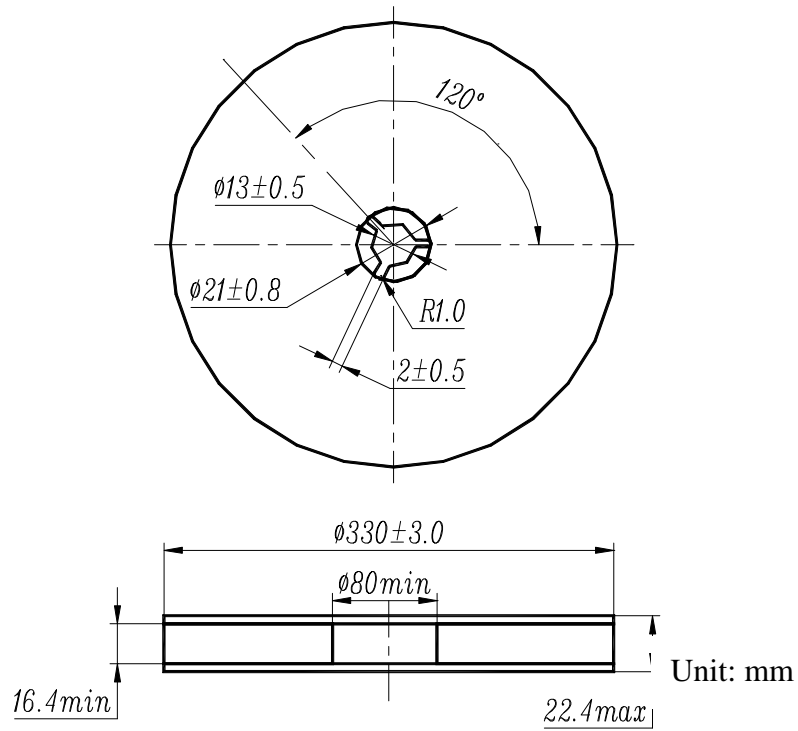

8.6 Packing Method Sketch Map

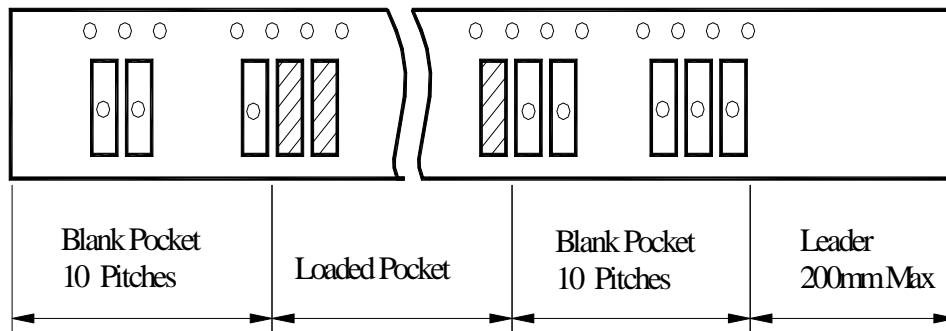

8.7 Test Condition Of Peeling Strength

